

Contact No. 182

YB2 Panel Seal

Thin Flush Mount Pushbuttons

New Square Actuator Option

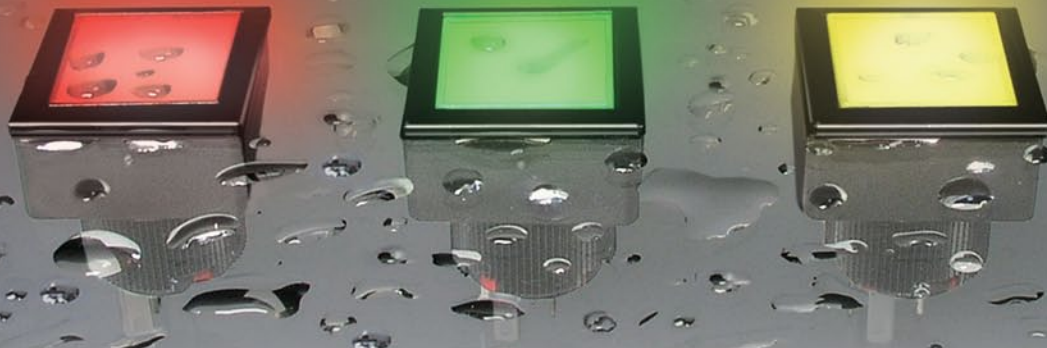

2011-01-26

NIKK
SWITCHES

General Specifications

Electrical Capacity (Resistive Load)

Power Level (silver):	3A @ 125V AC or 3A @ 250V AC or 3A @ 30V DC
Logic Level (gold):	0.4VA maximum @ 28V AC/DC maximum (Applicable Range 0.1mA ~ 0.1A @ 20mV ~ 28V)

Other Ratings

Contact Resistance:	50 milliohms maximum for silver; 100 milliohms maximum for gold
Insulation Resistance:	200 megohms minimum @ 500V DC
Dielectric Strength:	1,000V AC minimum between contacts for 1 minute minimum; 1,500V AC minimum between contacts & case for 1 minute minimum
Mechanical Life:	1,000,000 operations minimum for momentary circuit 200,000 operations minimum for maintained circuit
Electrical Life:	100,000 operations minimum
Nominal Operating Force:	Single pole: 1.5N Double pole: 3.0N
Contact Timing:	Nonshorting (break-before-make)
Travel:	Pretravel .059" (1.5mm); Overtravel .059" (1.5mm); Total Travel .118" (3.0mm) .098" (2.5mm) in Latchdown Position

Materials & Finishes

Bezel:	Black: Glass fiber reinforced polyamide (UL94V-0); Silver: Polycarbonate
Housing:	Glass fiber reinforced polyamide (UL94V-0)
Base:	Diallyl phthalate resin (UL94V-0)
Movable Contactor:	Phosphor bronze with silver or gold plating
Movable Contacts:	Phosphor bronze & silver alloy
Stationary Contacts:	Silver alloy or copper with gold plating
Switch Terminals:	Phosphor bronze with tin plating
Lamp Terminals:	Phosphor bronze with tin plating

Environmental Data

Operating Temperature Range:	-25°C through +50°C (-13°F through +122°F) for Illuminated -25°C through +70°C (-13°F through +158°F) for Nonilluminated
Humidity:	90 ~ 95% humidity for 96 hours @ 40°C (104°F)
Vibration:	10 ~ 55Hz with peak-to-peak amplitude of 1.5mm traversing the frequency range & returning in 1 minute; 3 right angled directions for 2 hours
Shock:	50G (490m/s ²) acceleration (tested in 6 right angled directions, with 5 shocks in each direction)
Sealing:	IP65 of IEC60529 standard

Installation

Mounting Torque:	0.785Nm (6.95 lb•in) maximum
Soldering Time & Temperature:	Manual Soldering: 390°C maximum for 4 seconds maximum

Standards & Certifications

Flammability Standards:	UL94V-0 housing, base & black or metallic silver bezel
UL:	File No. E44145 All solder lug models recognized at 3A @ 125/250V AC or 0.4VA @ 28V AC/DC maximum. Add "/CUL" to end of part number to order cULus mark on switch.

Distinctive Characteristics

24mm pushbutton with the shortest above-panel dimension (1.8mm) in the industry for splashproof design.

Meets IP65 of IEC60529 standards (similar to NEMA 4 and 13), providing dust tight and splashproof panel seal protection.

Tamper resistant 18mm square actuator.

Short body of .965" (24.5mm) conserves behind-panel space.

Distinctive long stroke and light touch actuation for clear indication of circuit status.

Choice of cap colors includes clear, red, green, amber, or metallic silver for enhanced panel appearance.

Brilliant illumination with multiple LED colors.

Bezel color options in silver or black.

Available in momentary and alternate action with latched down.

Crisp actuation and clear circuit status provided by snap-action contact mechanism. Arc barrier protects against crossover.

Combination solder lug and .110" quick connect terminals. Terminals are epoxy sealed to lock out flux, dust, solvents, and other contaminants, as well as to secure terminals and improve contact stability.

Custom legends on actuator available.

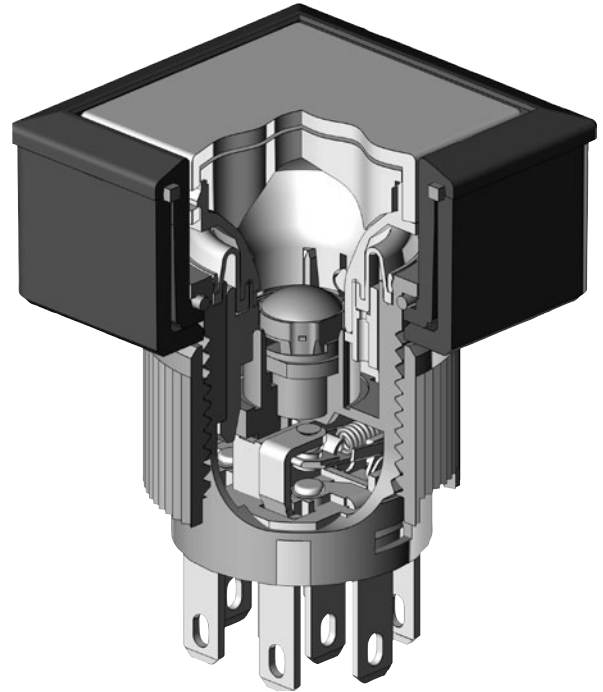

Round models also available, visit www.nikkaiswitches.com.

Actual Size

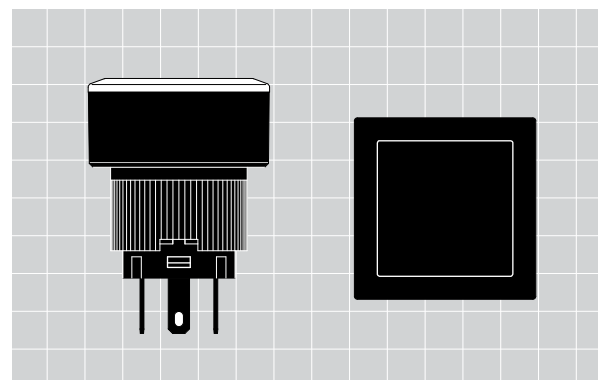

TYPICAL SWITCH

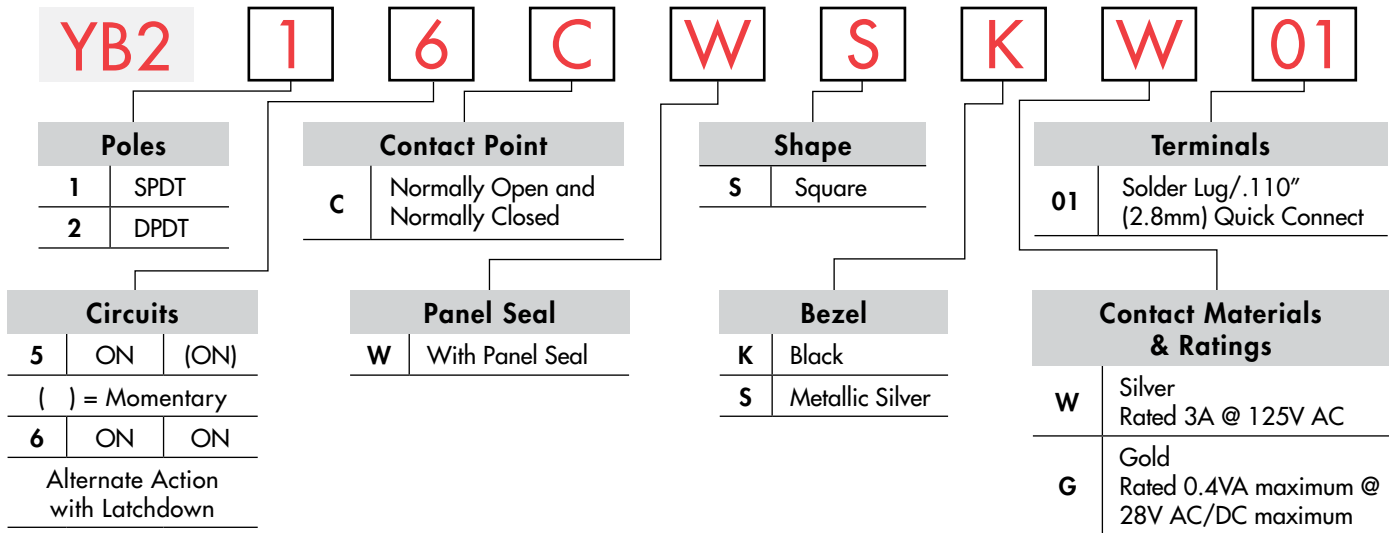

DESCRIPTION FOR TYPICAL ORDERING EXAMPLE

YB216CWSKW01-6F-JB

IMPORTANT:



Switches are supplied without cULus marking unless specified. Specific models & ratings noted on General Specifications page.

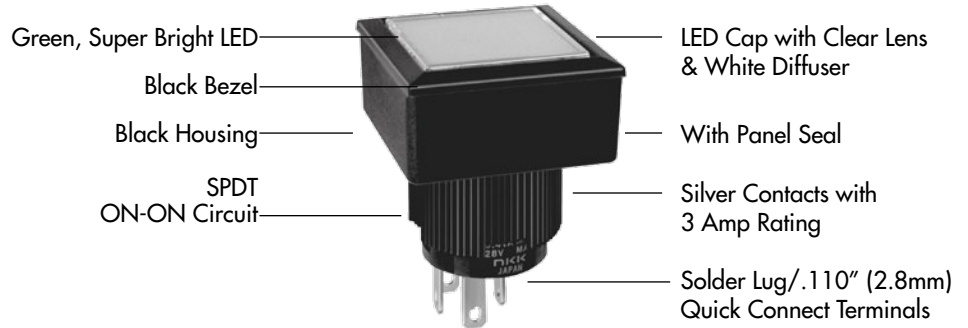

POLES & CIRCUITS

		Plunger Position () = Momentary		Connected Terminals		Throw & Switch/Lamp Schematics
Pole	Model	Normal	Down	Normal	Down	
SP	YB215 YB216	ON ON	(ON) ON	1-3	1-2	Notes: Switch is marked with NC, NO, COM, L+, L-. Lamp circuit is isolated and requires an external power source. SPDT
DP	YB225 YB226	ON ON	(ON) ON	1-3 4-6	1-2 4-5	DPDT

CONTACT POINT



Normally Open and Normally Closed

Contact points are both Normally Open and Normally Closed.

PANEL SEAL



Panel Seal

O-ring and square gasket provide panel seal protection meeting IP65 of IEC60529 standards.

ORDERING EXAMPLE

6 F

JB

LEDS

Bright LED

LED Colors		Resistor	
5C	Red	No Code	No Resistor (not for Green)
5D	Amber		
5F	Green		
		05	5-volt
		12	12-volt
		24	24-volt

Super Bright LED

6B	White
6F	Green
6G	Blue

Nonilluminated

N	No Lamp
---	---------

Cap Types & Colors

Lens/Diffuser Colors

JB	Clear/White
CB	Red/White
EB	Yellow/White
FB	Green/White

LED & cap need to be the same color. Yellow cap pairs with amber LED to achieve amber illumination. Code JB may be combined with all LED colors.

Lens/Diffuser Cap Colors

JB	Clear/White
----	-------------

Cap Color

S	Metallic Silver
JB	Clear/White
CB	Red/White
EB	Yellow/White
FB	Green/White

SHAPE

S Square

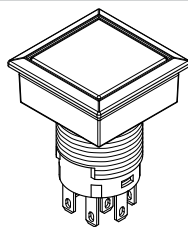

BEZEL

K Black
S Metallic Silver

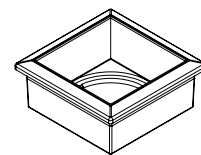

CONTACT MATERIALS & RATINGS

W Silver Contacts

Power Level: 3A @ 125/250V AC
Switch base is green

G Gold Contacts

Logic Level: 0.4VA max. @ 28V AC/DC max.
Switch base is red

TERMINALS

01 Solder Lug/
.110" (2.8mm) Quick Connect

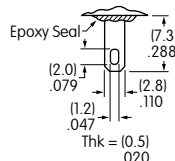

BRIGHT & SUPER BRIGHT LEDS

The electrical specifications shown are determined at a basic temperature of 25°C. LED circuit is isolated and requires an external power source. If the source voltage exceeds the rated voltage, a ballast resistor is required.
Base of AT634 and AT636 is Black for 5V, Light Blue for 12V and Gray for 24V.

Electrical Specifications for Bright LED without Resistor

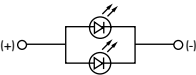
Bright AT628  T-1 Bi-pin 	Colors Available: 5C Red 5D Amber No Code No Resistor	Unit			
	LED Colors	Red	Amber		
	Forward Peak Current	I_{FM}	40	40	mA
	Continuous Forward Current	I_F	26	26	mA
	Forward Voltage	V_F	1.9	2.0	V
	Reverse Peak Voltage	V_{RM}	4	4	V
	Current Reduction Rate Above 25°C	ΔI_F	0.50		mA/°C
Ambient Temperature Range	-25 ~ +50			°C	

Electrical Specifications for Bright Red & Amber LED with Resistor

Bright AT634  T-1 1/4 Bi-pin	Colors Available: 5C Red 5D Amber 05 12 24	Unit				
	Forward Peak Current	I_{FM}	—	—	—	mA
	Continuous Forward Current	I_F	25	20	10	mA
	Forward Voltage	V_F	5	12	24	V
	Reverse Peak Voltage	V_{RM}	4	8	16	V
	Current Reduction Rate Above 25°C	ΔI_F	—	—	—	mA/°C
	Ambient Temperature Range	-25 ~ +50			°C	

AT634
5-volt,
2-element
with Resistor

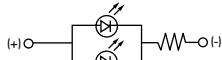

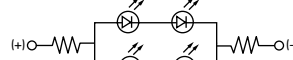

AT634
12-volt,
4-element
with Resistor



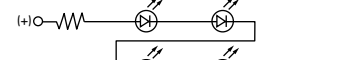

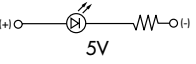
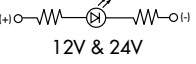

AT634
24-volt,
4-element
with Resistor



Electrical Specifications for Bright Green LED with Resistor

Bright AT636  T-1 1/4 Bi-pin  5V  12V & 24V	Colors Available:  5F Green 05 12 24	Unit				
	Forward Peak Current	I_{FM}	—	—	—	mA
	Continuous Forward Current	I_F	11	9.5	8.7	mA
	Forward Voltage	V_F	5	12	24	V
	Reverse Peak Voltage	V_{RM}	5	5	5	V
	Current Reduction Rate Above 25°C	ΔI_F	—	—	—	mA/°C
	Ambient Temperature Range	-25 ~ +50			°C	

Electrical Specifications for Super Bright LED

Super Bright AT625G Blue AT631B White AT632F Green  T-1 Bi-pin 		(+) (○)  (○) (-)	Colors: 6B White 6F Green 6G Blue	Unit		
	Forward Peak Current	I_{FM}	30	30	30	mA
	Continuous Forward Current	I_F	20	20	20	mA
	Forward Voltage	V_F	3.6	3.5	3.6	V
	Reverse Peak Voltage	V_{RM}	5	5	5	V
	Current Reduction Rate Above 25°C	ΔI_F	0.50		mA/°C	
	Ambient Temperature Range	-25 ~ +50			°C	

BALLAST RESISTOR CALCULATION FOR LEDS

If the source voltage is greater than the rated voltage of a lamp or LED, a ballast resistor must be connected in series with the lamp. This circuit diagram and formula will assist in calculating the value of the required ballast resistor.

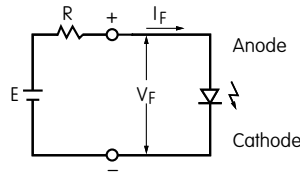

$$R = \frac{E - V_F}{I_F}$$

Where: R = Resistor Value (Ohms)
 E = Source Voltage (V)
 V_F = Forward Voltage (V)
 I_F = Forward Current (A)

CAPS & CAP COLORS

AT3025 Cap for Illuminated

Lens/Diffuser Colors Available:

- JB** Clear/White
For Bright & Superbright LEDs
- CB** Red/White
For Bright LED only
- EB** *Yellow/White
For Bright LED only
- FB** Green/White
For Bright LED only

AT3027 Cap for Nonilluminated

Cap Color Available:

- S** Metallic Silver

Note: AT3025 Cap can also be used without illumination.

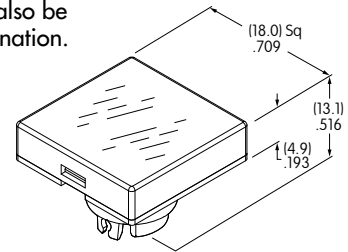
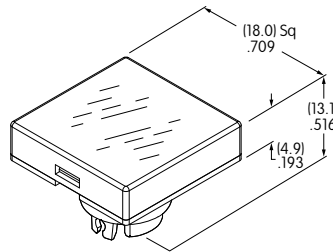

*Yellow cap pairs with amber LED to achieve amber illumination.

Material for Lens & Diffuser: Polycarbonate

TYPICAL SWITCH DIMENSIONS

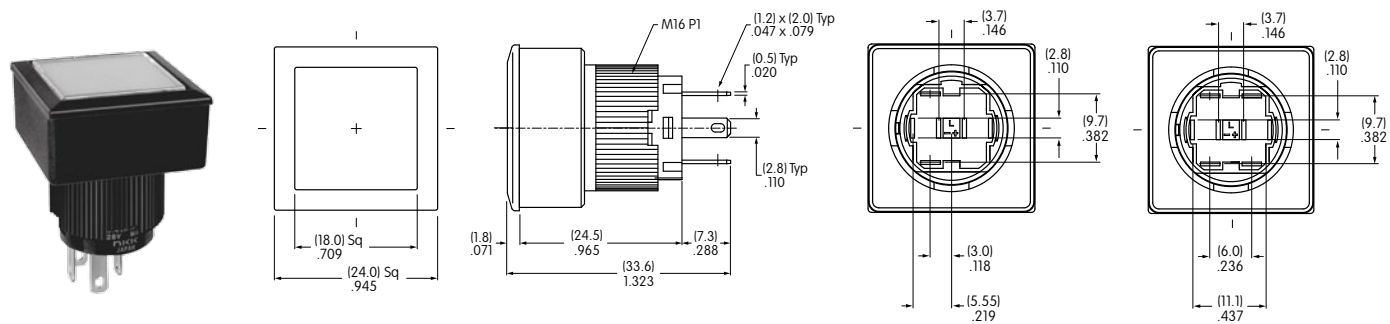

YB216CWSKW01-6F-JB

PANEL THICKNESS & CUTOUT

Panel Thickness
 .020" ~ .197"
 (0.5mm ~ 5.0mm)

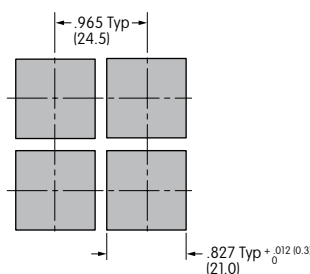

Side-by-side Mounting

ASSEMBLY INSTRUCTIONS

1. Remove knurled nut.

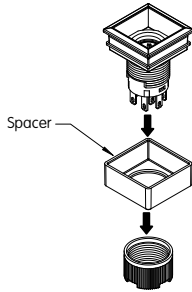

2. Remove bezel and o-ring from housing.

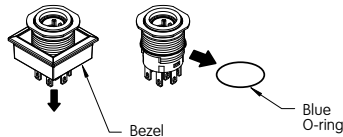

3. Install LED.

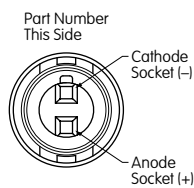

LEDs
AT634 & AT636

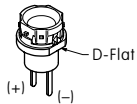

Align D-flat on LED with Part Number on switch for appropriate polarity and insert LED into base.



LED AT628

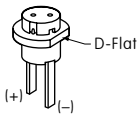

Align D-flat on LED with Part Number on switch for appropriate polarity and insert LED into base.



LEDs AT625G,
AT631B,
AT632F

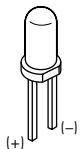

The larger metal part within the LED represents the cathode (-). Align LED for appropriate polarity and insert LED into base.

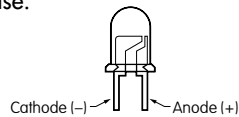

4. Align tabs (B) on both sides of actuator with the projections (A) inside of the housing and push actuator firmly down to snap in.

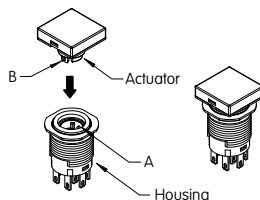

5. Install the blue o-ring which was removed in step 2 at the inside bottom of the bezel.

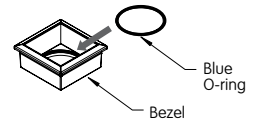

6. Align tab inside of the bezel with keyway on housing and bring bezel back into its original position.

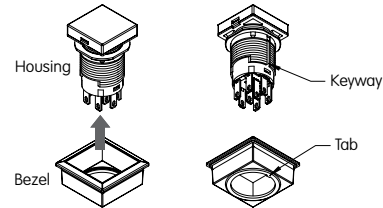

7. Before installing into panel, make sure that the square gasket is present at the back of the bezel. Align keyway on bezel with tab in panel and push switch all the way into the panel.

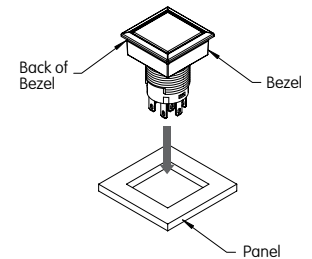

8. Attach knurled nut behind panel and tighten. Make sure that bezel and actuator fit properly and that there is no space between bezel and panel. Do not overtighten.

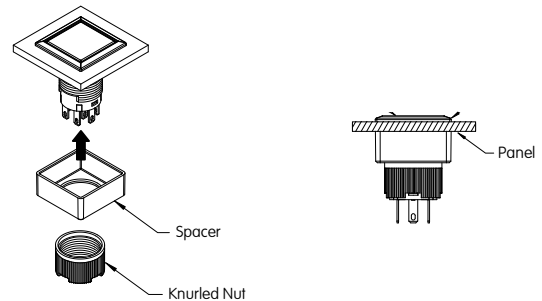

LEGENDS

Shaded Area is Printable Area for Film Inserts

Recommended Print Method:

Screen Print; Epoxy based ink is recommended

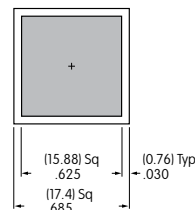

Film Material and Thickness:
Clear Polyester, 4 mil max.

Availability March 16, 2011

Corporate Headquarters
Nihon Kaiheiki Ind. Co., Ltd.
Kawasaki, Japan
T +81.44.813.8008
F +81.44.813.8038
<http://www.nikkai.co.jp>

International
Nihon Kaiheiki Ind. Co., Ltd.
<http://www.nikkaiswitches.com>