

General Specifications

Electrical Capacity (Resistive Load)

Switching Rating:	100mA @ 5V DC
Nonswitching Rating:	100mA @ 50V DC

Other Ratings

Contact Resistance:	100 milliohms maximum for circuit; 30 milliohms maximum for contact point
Insulation Resistance:	1,000 megohms minimum @ 250V DC
Dielectric Strength:	250V AC minimum for 1 minute minimum
Mechanical Life:	10,000 detent operations minimum
Electrical Life:	10,000 detent operations minimum

Notes: A detent operation is one actuator position operation or stepping.
A cycle is one 360° rotation. 10,000 detent operations equal 625 cycles for hexadecimal devices or 1,000 cycles for decimal devices.

Nominal Operating Torque:	0.008Nm for decimal devices; 0.01Nm for hexadecimal devices
Contact Timing:	Nonshorting

Materials & Finishes

Actuator:	Screwdriver and Plastic Shaft - Glass fiber reinforced polyamide (UL94V-0)
Housing & Base:	Glass fiber reinforced polyamide (UL94V-0)
Leaf Spring:	Stainless steel
Movable Contacts:	Copper alloy with gold plating
Stationary Contacts:	Phosphor bronze with gold plating
Terminals:	Phosphor bronze with gold plating

Environmental Data

Operating Temperature Range:	-25°C through +85°C (-13°F through +185°F)
Humidity:	90 ~ 95% humidity for 240 hours @ 40°C (104°F)
Vibration:	10 ~ 55Hz with peak-to-peak amplitude of 1.5mm traversing the frequency range & returning in 5 minutes; 3 right angled directions for 2 hours
Shock:	50G (490m/s ²) acceleration (tested in 6 right angled directions, with 5 shocks in each direction)

Processing

Soldering:	Reflow Soldering Recommended. See Profile A in Supplement section. Manual Soldering: See Profile A in Supplement section. Note: During soldering process, set the switch to the following position: FR02FR10P, FR02FR16P, FR02KR10P, FR02KR16P: 0 position; FR02FC10P, FR02KC10P: 7 position; FR02FC16P, FR02KC16P: F position
Cleaning:	These devices are not process sealed. Hand clean locally using alcohol based solution.

Standards & Certifications

Flammability Standards:	UL94V-0 rated actuator, housing, & base The FR02 Series rotaries have not been tested for UL recognition or CSA certification. These switches are designed for use in a low-voltage, low-current circuit. When used as intended, the results do not produce hazardous energy.
--------------------------------	--

Distinctive Characteristics

Slim .150" (3.8mm) body has the lowest profile in the industry and allows close stacking of PC boards.

Highly visible legends and choice of screwdriver or shaft actuators with arrow position indication provide trouble-free code setting.

Detent mechanism gives crisp, positive action for accurate switch setting.

Use of heat resistant resin allows infrared convection reflow soldering.

Gull-winged terminals ensure mechanical stability during soldering and simplify solder joint inspection.

Cam activated movable contact and gold contacts assure contact reliability and continuity.

Tape-reel packaging meets EIA-481-2 Standard.

Coplanarity: all considered surfaces must lie between two parallel planes that are a maximum distance apart of .0059" (0.15mm). (Additional coplanarity details in Terms and Acronyms in the Supplement section.)

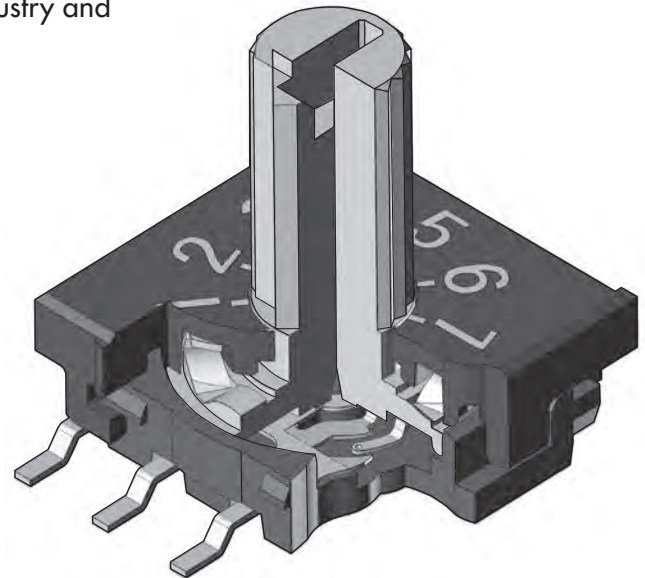

Actual Size

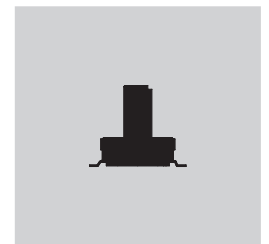

TRUTH TABLES (CIRCUITS & POSITIONS)

Actuator Position ● = ON		10 Decimal										16 Hexadecimal																					
		0	1	2	3	4	5	6	7	8	9	0	1	2	3	4	5	6	7	8	9	A	B	C	D	E	F						
Terminal No. (Output)																																	
R Real Coded Model Numbers: FR02FR, FR02KR	1		●		●		●		●		●		●		●		●		●		●		●		●		●		●				
	2			●	●			●	●			●	●			●	●			●	●			●	●			●	●				
	4				●	●			●	●			●	●			●	●			●	●			●	●			●	●			
	8					●	●	●	●					●	●	●	●					●	●	●	●					●	●		
C Complement Coded Model Numbers: FR02FC, FR02KC	1	●		●		●		●		●		●		●		●		●		●		●		●		●		●		●			
	2	●	●			●	●			●	●			●	●			●	●			●	●			●	●			●	●		
	4	●	●	●	●			●	●	●	●			●	●	●	●			●	●	●	●			●	●	●	●			●	●
	8	●	●	●	●	●	●	●	●					●	●	●	●	●	●					●	●	●	●	●	●	●	●	●	●

Terminal numbers are actually on the switch.

TYPICAL SWITCH ORDERING EXAMPLE

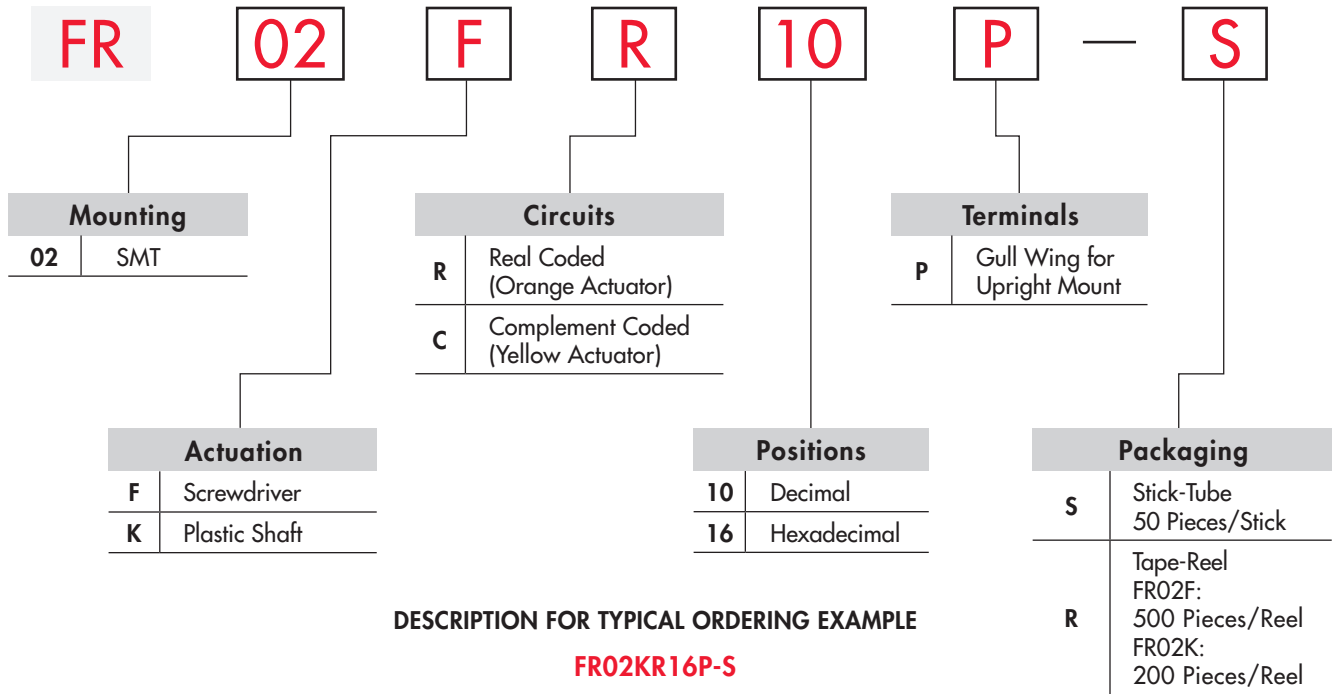

DESCRIPTION FOR TYPICAL ORDERING EXAMPLE

FR02KR16P-S

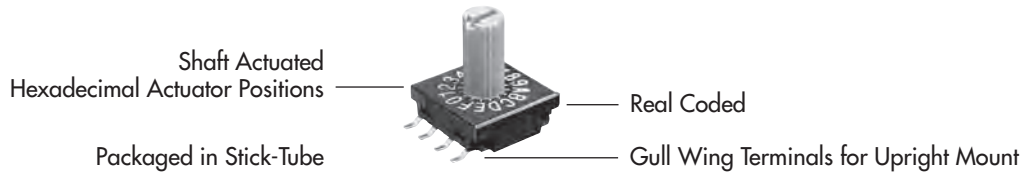

ACTUATION

F Screwdriver
Adjusted with a flat tipped screwdriver

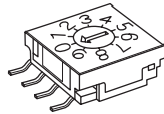

K Plastic Shaft
Adjusted by hand or with flat tipped screwdriver

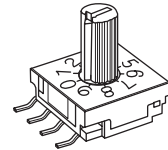

Actuators are fully rotational either clockwise or counterclockwise.
Actuator Colors: Orange for real coded devices; Yellow for complement coded devices.

TYPICAL SWITCH DIMENSIONS

P Upright • Screwdriver



FR02FC10P

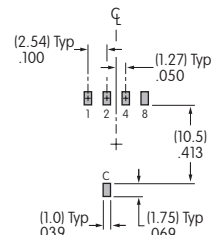
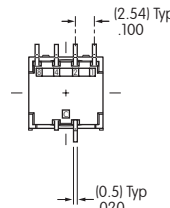
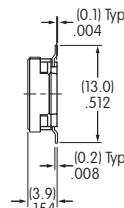
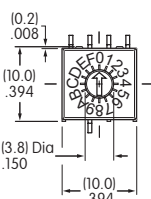
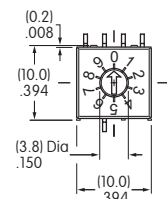

TYPICAL SWITCH DIMENSIONS

Upright • Plastic Shaft

P

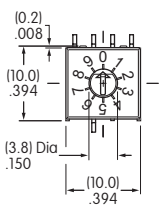

Decimal

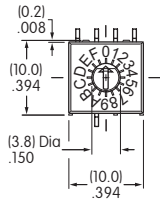

Hexadecimal

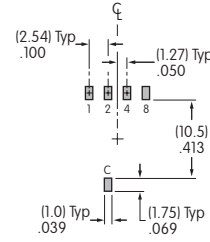
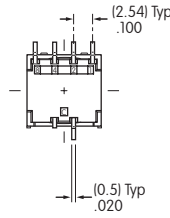
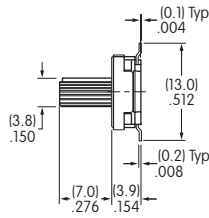

FR02KC16P

PACKAGING

S Stick-Tube

FR02F & FR02K
Each stick-tube contains 50 switches.
Switches must be ordered in 50-piece increments.

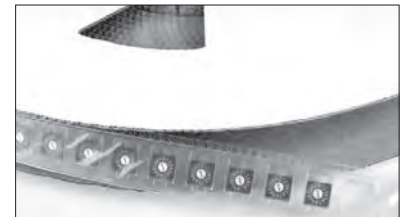
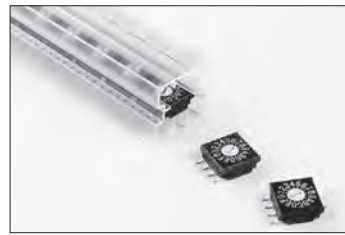
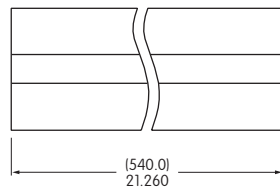
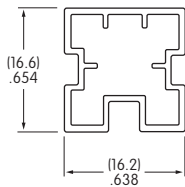

R Tape-Reel

FR02F
Switches must be ordered in 500-piece increments.
This packaging meets EIA-481-2 Standard.

Each tape-reel of 550 pockets contains 500 switches.
Minimum Leader Length: 15.748" (400mm)
Minimum Trailer Length: 6.299" (160mm)

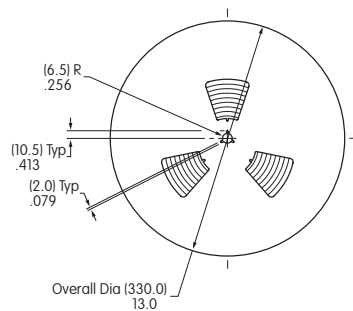

FR02F

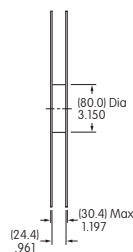

FR02K

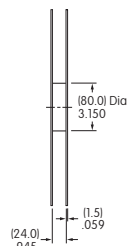

FR02K
Switches must be ordered in 200-piece increments.
This packaging meets EIA-481-2 Standard.

Each tape-reel of 250 pockets contains 200 switches.
Minimum Leader Length: 15.748" (400mm)
Minimum Trailer Length: 6.299" (160mm)

